

Glass Passivated Single-Phase Bridge Rectifier, 25A

GBPC2506 Thru GBPC2512

FEATURES

- UL recognition file number E320098
- Universal 3-way terminals: snap-on, wire wrap-around, or PCB mounting
- Typical IR less than 1.0 μ A
- High surge current capability
- Low thermal resistance
- Solder dip 260°C, 40s
- Compliant to RoHS
- Glass passivated chips

TYPICAL APPLICATIONS

General purpose use in AC/DC bridge full wave rectification for power supply, home appliances, office equipment, industrial automation applications.

MECHANICAL DATA

Case: GBPC, GBPC-W

Epoxy meets UL 94 V-O flammability rating

Terminals: Nickel plated on faston lugs or silver plated on wire leads, solderable per J-STD-002 and JESD22-B102. Suffix letter "W" added to indicate wire leads (e.g. GBPC2506W).

Polarity: As marked, positive lead by beveled corner

Mounting Torque: 20 inches-lbs. max. (M5 screw)

Weight: 14g (0.49 ozs)

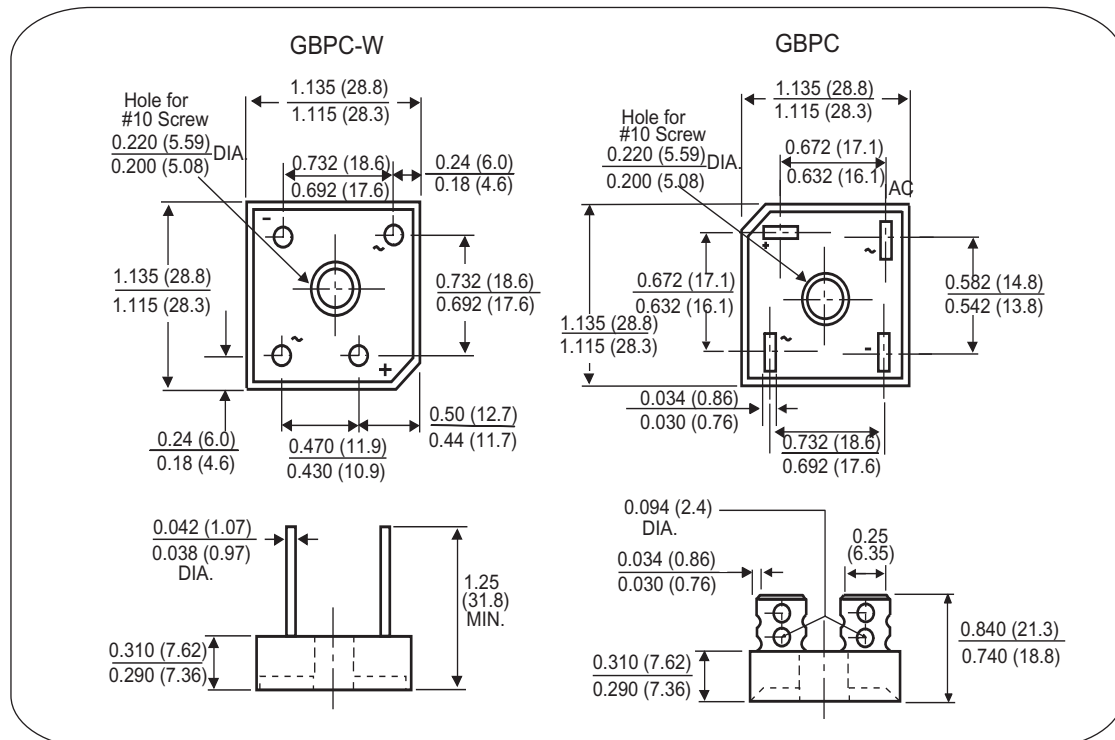
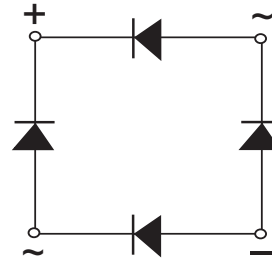
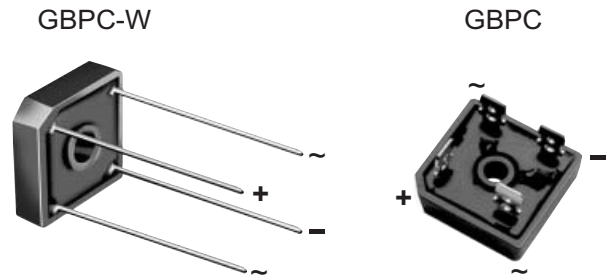

PRIMARY CHARACTERISTICS	
$I_{F(AV)}$	25A
V_{RRM}	600V to 1200V
I_{FSM}	300A
I_R	5 μ A
V_F	1.1V
$T_{Jmax.}$	150°C

MAXIMUM RATINGS ($T_A = 25^\circ\text{C}$ unless otherwise noted)						
PARAMETER	SYMBOL	GBPC25				UNIT
		06	08	10	12	
Maximum repetitive peak reverse voltage	V_{RRM}	600	800	1000	1200	V
Maximum RMS voltage	V_{RMS}	420	560	700	840	V
Maximum DC blocking voltage	V_{DC}	600	800	1000	1200	V
Maximum average forward rectified output current (Fig. 1)	$I_{F(AV)}$	25				A
Peak forward surge current single sine-wave superimposed on rated load	I_{FSM}	300				A
Rating (non-repetitive, for t greater than 1 ms and less than 8.3 ms) for fusing	I^2t	375				A ² s
RMS isolation voltage from case to leads	V_{ISO}	2500				V
Operating junction storage temperature range	$T_{J, T_{STG}}$	-55 to 150				°C

ELECTRICAL CHARACTERISTICS ($T_A = 25^\circ\text{C}$ unless otherwise noted)							
PARAMETER	TEST CONDITIONS	SYMBOL	GBPC25				UNIT
			06	08	10	12	
Maximum instantaneous forward drop per diode	$I_F = 12.5\text{A}$	V_F	1.1				V
Maximum reverse DC current at rated DC blocking voltage per diode	$T_A = 25^\circ\text{C}$	I_R	5				μ A
	$T_A = 150^\circ\text{C}$		500				
Typical junction capacitance per diode	4V, 1MHz	C_J	300				pF

THERMAL CHARACTERISTICS ($T_A = 25^\circ\text{C}$ unless otherwise noted)						
PARAMETER	SYMBOL	GBPC25				UNIT
		06	08	10	12	
Typical thermal resistance	$R_{\theta JC^{(1)}}$	1.9				°C/W

Notes

(1) With heatsink

(2) Bolt down on heatsink with silicone thermal compound between bridge and mounting surface for maximum heat transfer with M5 screw

Fig.1 Maximum Output Rectified Current

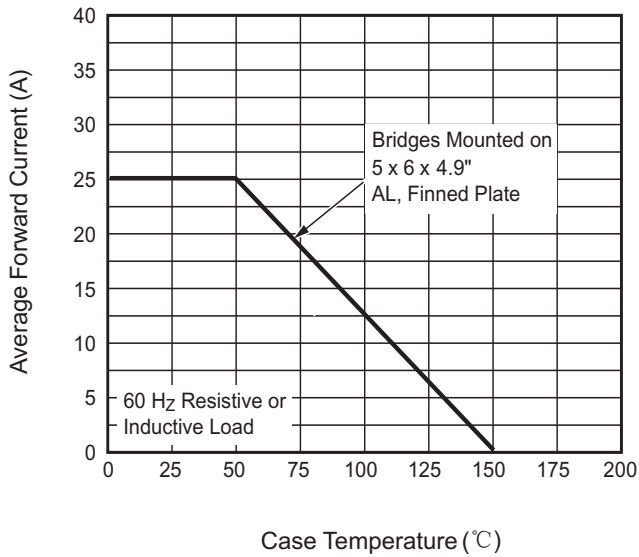

Fig.2 Maximum Output Rectified Current

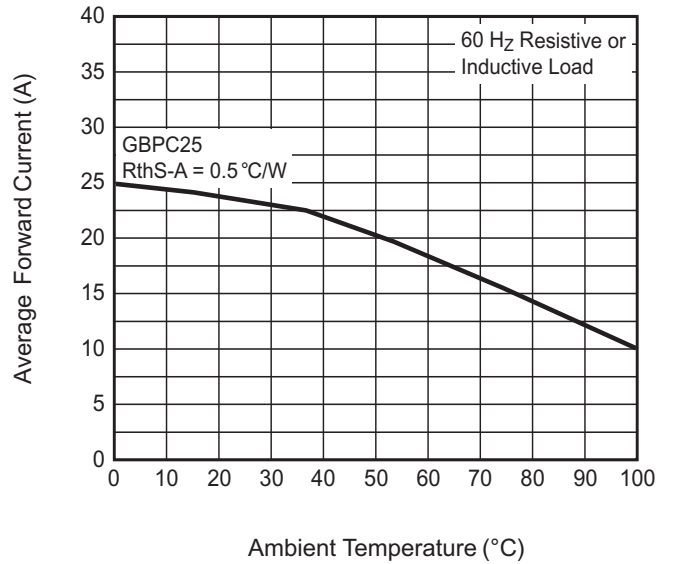

Fig.3 Maximum Power Dissipation

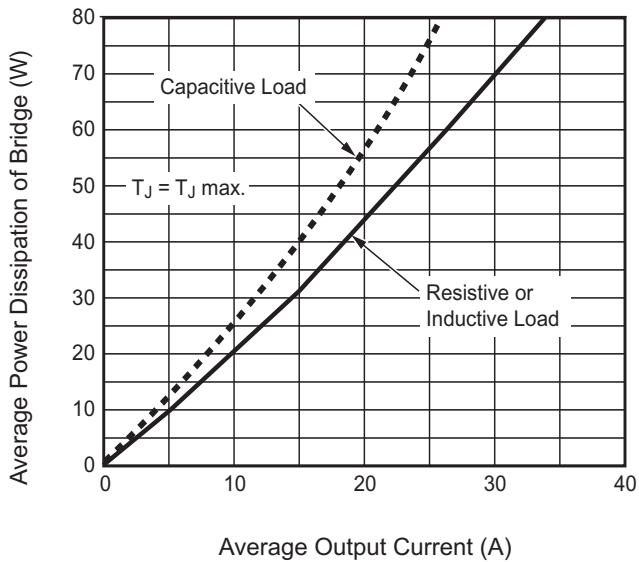

Fig.4 Maximum Non-Repetitive Peak Forward Surge Current Per Diode

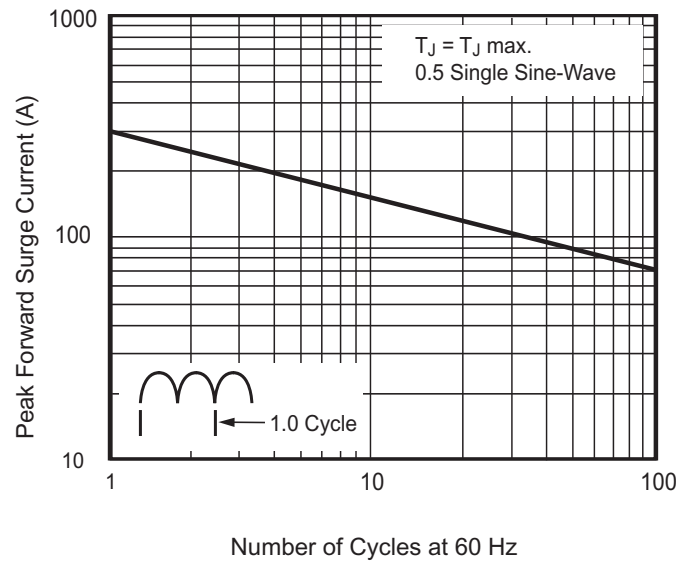

Fig.5 Typical Instantaneous Forward Characteristics Per Leg

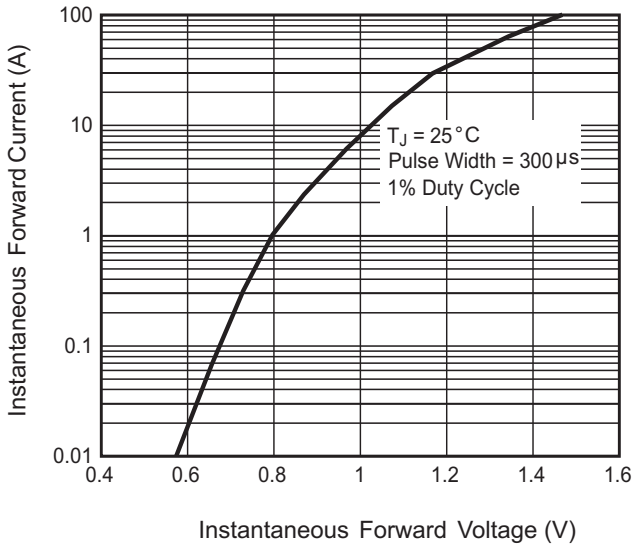

Fig.6 Typical Reverses Leakage Characteristics Per Leg

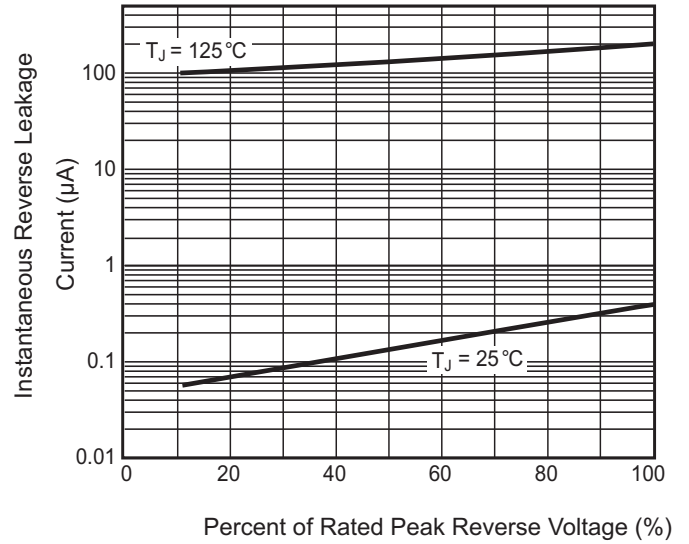

Fig.7 Typical Junction Capacitance Per Leg

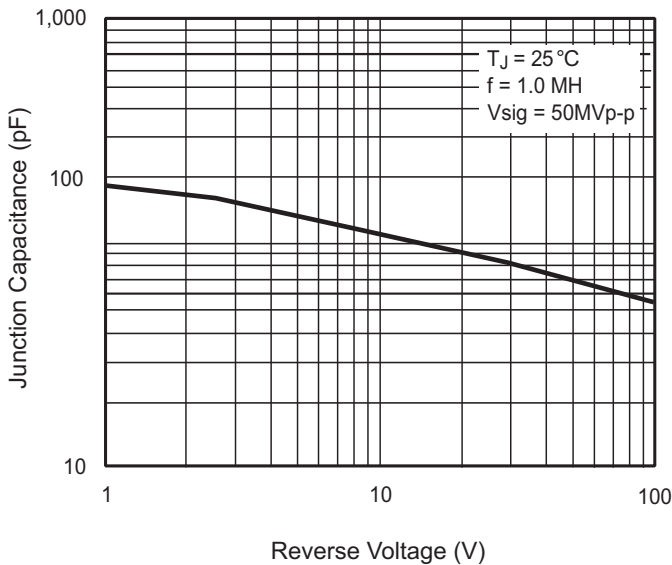

Fig.8 Typical Transient Thermal Impedance Per Leg

